

MULTILOGGER - QUICK START MANUAL

M1140, M1200, M1200E, M1220, M1300, M1320, M1321, M1322, M1323, M1440

The Multilogger has been designed for measuring and recording physical and electric quantities with an adjustable logging interval from 1 second to 24 hours. The device is equipped with 4 inputs (connectors) for external probes or signals. Moreover, some versions also include an internal atmospheric pressure and/or CO₂ concentration sensor. The production line consists of several models with various combinations of the input ranges of the measured quantities.

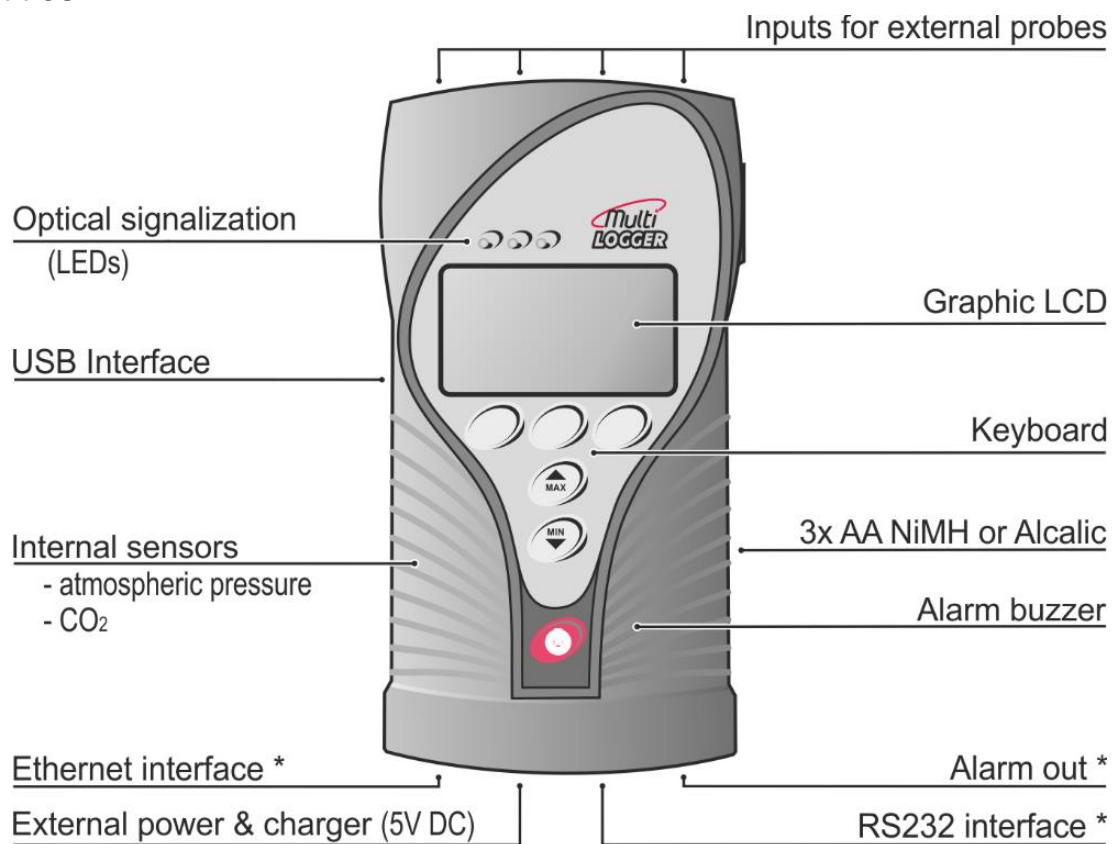

* these components are not the part of multilogger M1200E

Getting started

Before putting the Multilogger into operation it is necessary to set up the device inputs in accordance with connected probes and for the required measuring ranges. This settings can be performed only using a computer with the **COMET Vision** software.

- Install the **Comet Vision** software that is available at www.cometsystem.cz to your computer. Launch installer and follow the instructions. If you purchased a license for full version, register it.

The minimum hardware and software requirements:

- Windows 7 and later or Windows Server 2008 R2 and later
- 1.4 GHz processor
- RAM 1 GB

- Connect the appropriate probes or signals to the inputs as described in the last part of this manual.
- The Multilogger (with the exception of version M1200E) is supplied with included pre-charged NiMH batteries. Switch on the device - push the red switch button and check the battery status in the menu *System Information* (click *Enter – Next*). The value should be over 60%. If you do not change the device settings, the batteries will be automatically recharged during device operation in case of a connected the external AC adapter.
- Launch the installed software Comet Vision and connect the Multilogger with PC via USB interface using supplied cable. The device is automatically added to the list and thus is ready for further communication with SW:

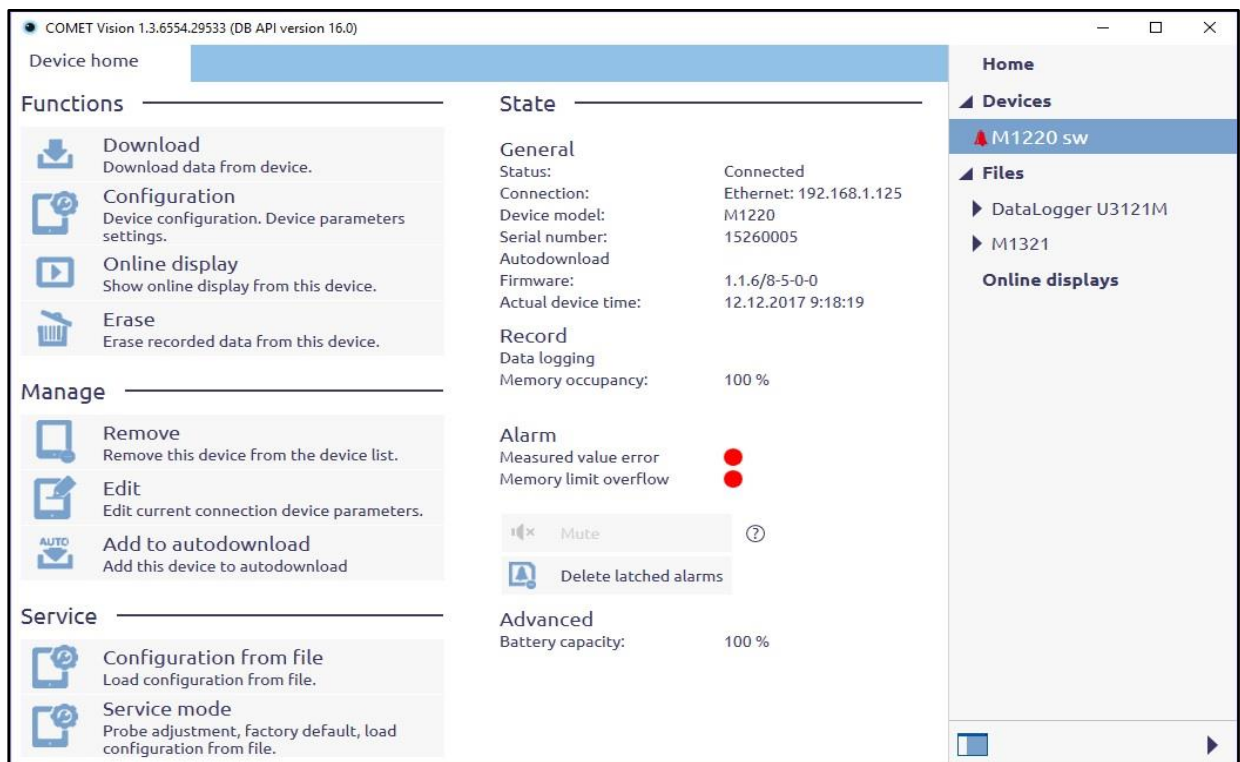

- Click the button *Configuration* and then click *Inputs*. List of inputs will be displayed:

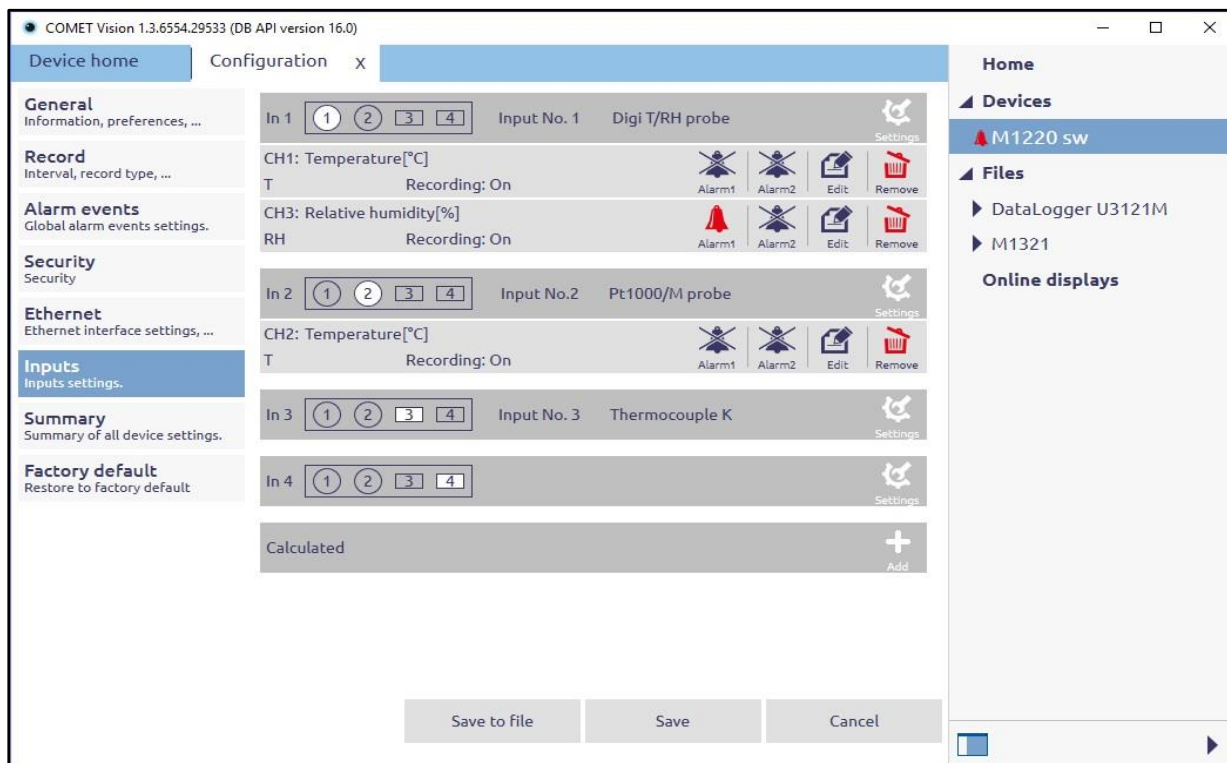

This panel shows the configuration of the new device with the factory settings. For each input is shown the current type of connected probe or its measuring range.

Change the settings of the selected input is possible by pressing *Settings* icon:

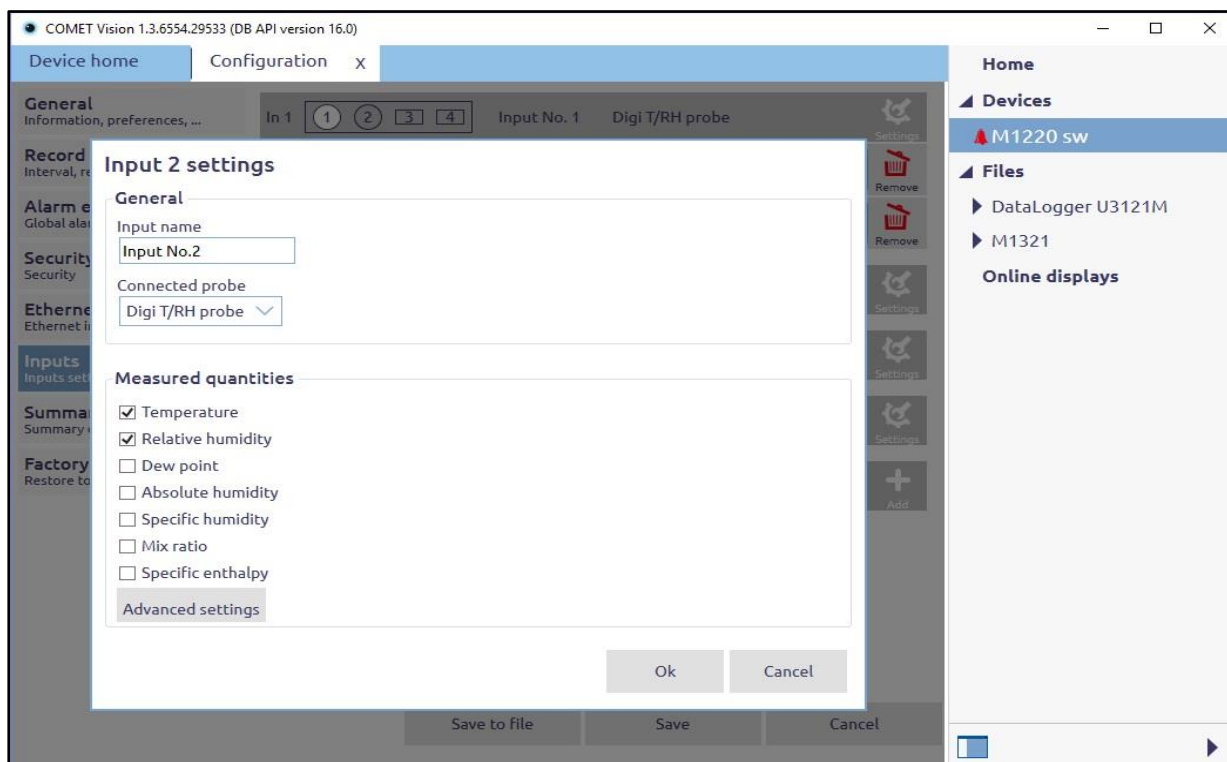

Here it is possible in the dropdown menu to change the type of probe connected to the device input and to assign the appropriate input name for the easier orientation. For each type of probe there is available different list of measured quantities of which can be selected as user needs. Clicking to *OK* the newly selected measured quantities will be assigned to the currently free channels. The maximum number of channels, with which the Multilogger can operate is 16. Then you can continue to set next input.

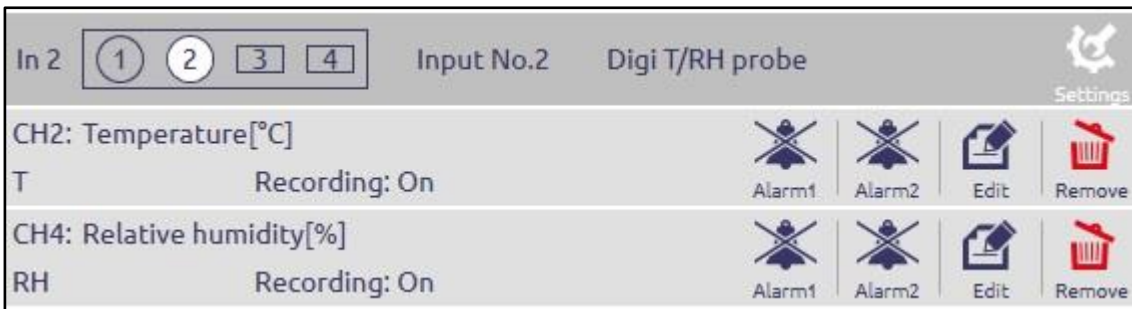

In the line of each measured variable (ie. channel), you can change its other settings (eg. Alarm limits, alarms indication, the channel recording, etc.). For these settings, use *Alarm1*, *Alarm 2* and *Edit* icon.

In these settings, pay attention to the least the following items:

- check and, if necessary, correct date and time in the Multilogger (option *General/Date and time*)
- set the required recording interval and start of recording (option *Record*)
- If the device will be connected to the Ethernet, set the parameters according to the information from your IT administrator (*Ethernet* option)

All the settings can be saved to the device by clicking on the *Save*.

Connection of probes and measured signals to the device inputs

Manufactured models differ from each other by their input ranges and by input connectors. There are three types of connectors / terminals:

MiniDIN connector

It is used for connection of the DigiS/M..., DigiL/M..., Pt1000/M probes and for external CO₂ probe. Plug properly oriented probe connector to the input of Multilogger. You can follow the optical key for correct position. The input connector marked "CO₂" is designed for external CO₂ probe only.

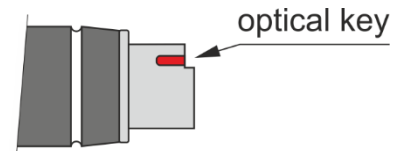

Universal thermocouple connector

Plug properly oriented connector to the input of Multilogger. The connector is mechanically coded using a wider pin and can be plugged in one position only. Make sure that the wires of probes and measuring junctions are not electrically connected to any other conductive parts! Electrical coupling among thermocouples can cause large measurement errors or instable values! To obtain correct measurement values, the Multilogger has to be temperature-stabilized!

Two voltage ranges are available on each universal thermocouple connector for measuring small voltages. Use the white uncompensated connector connected according to the picture in this case.

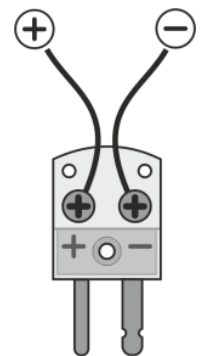

Connection terminals

Inputs (0 to 20) mA, (0 to 10) V, binary inputs and the counter are equipped with a two-part, self-locking WAGO terminal block. Insert flat-bladed screwdriver to rectangle terminal hole and push screwdriver towards away from you - contact is released. Insert wire to released terminal (circular hole behind the rectangular one) and close the terminal by removing the screwdriver.

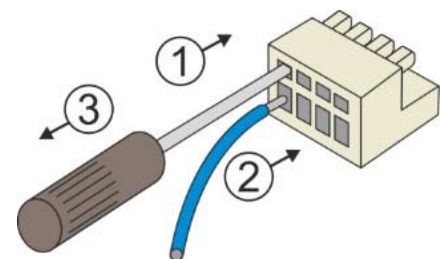

The terminal block can be removed from the device without the need to disconnect individual wires!

Connection of the transmitter with voltage output:

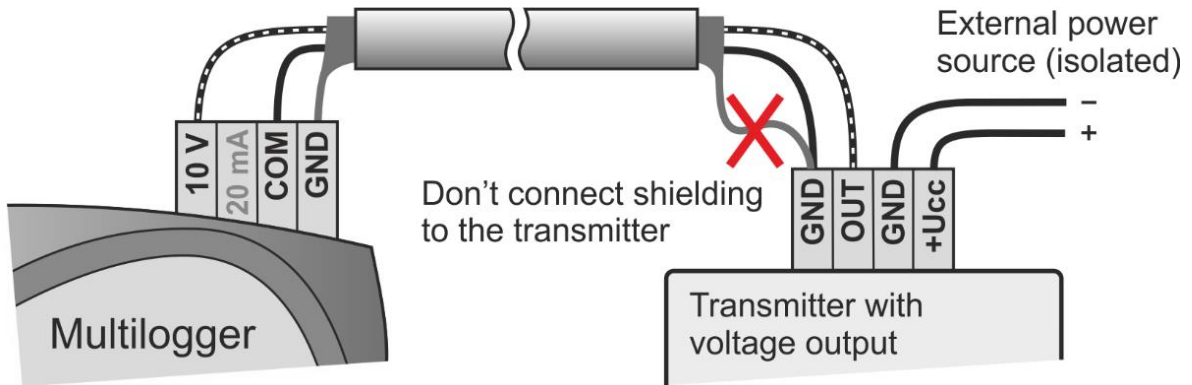

Connection of the transmitter with the current output (active):

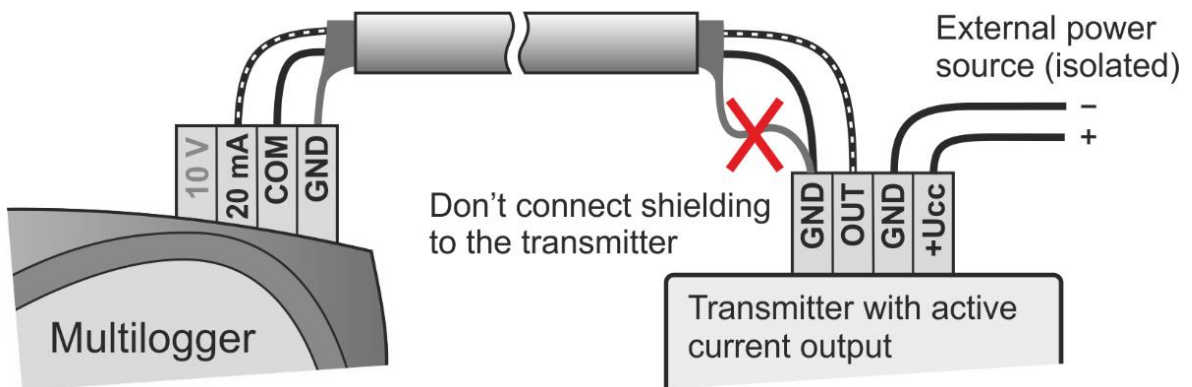

Connection of the transmitter with the current output (passive):

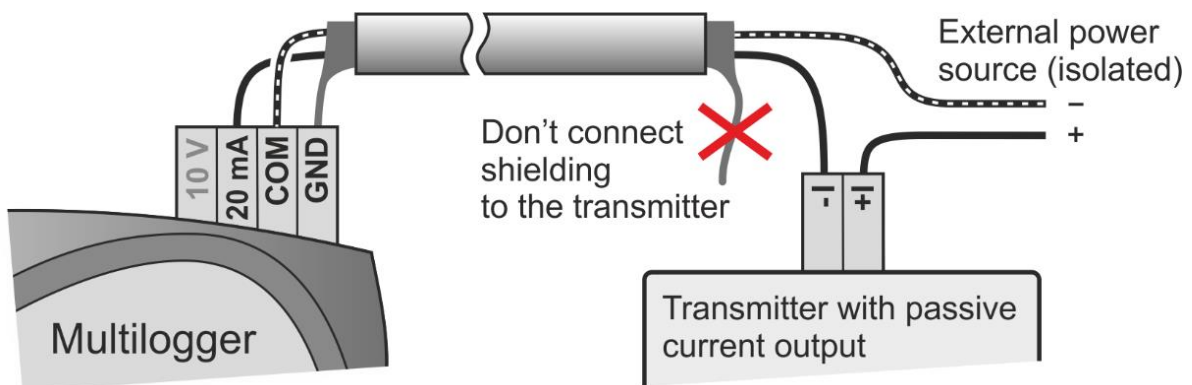

Connection of the transmitter with the two current outputs (passive):

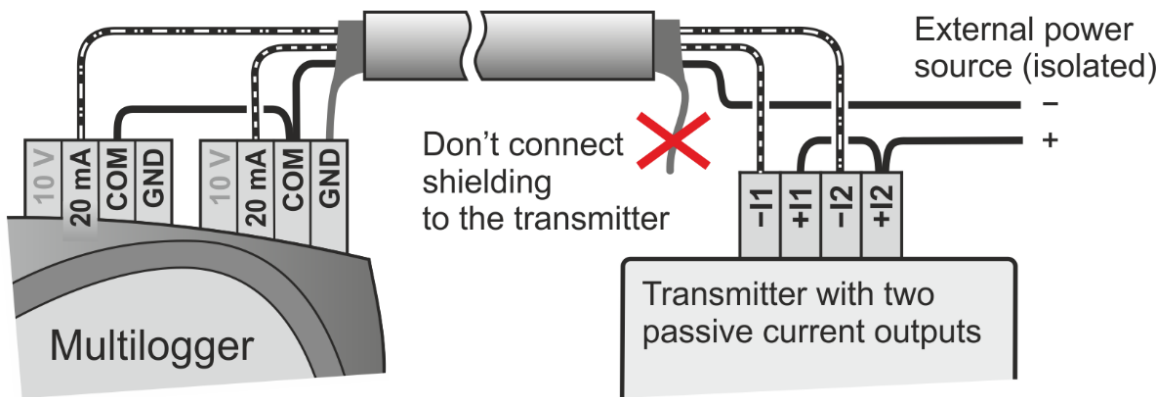

Connection of the binary and counter input:

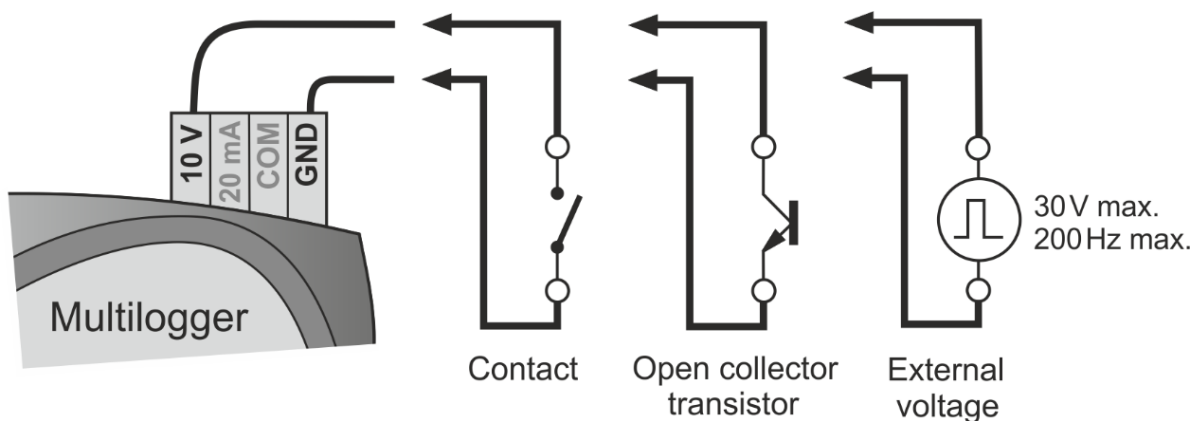

Warning

To complement the information in this data sheet read the manual and other documentations that are available in the Download section for a particular device at www.cometsystem.com.